

High speed door

Albany HS9110P

ASSA ABLOY

ASSA ABLOY Entrance Systems

The global leader in door opening solutions



Medium-sized high speed door for inside applications with enhanced drive system

The Albany HS9110P is an evolution of the Albany HS9010P. The enhanced drive system gives increased durability and comfort. The main features of the Albany HS9110P are:

- Medium-sized, max. 5500 x 5500 mm
- Heavy-duty operations
- Inside usage
- Galvanised steel construction
- Unique enhanced direct door drive system
- Opening speed up to 2,4 m/s

The fast opening and closing speed improves your traffic flow, provides employee comfort, and saves energy.

The unique direct door drive system eliminates the need for weighted bottom bars or tension systems by actively driving the door curtain. An exceptional reliability and smooth operation is ensured by a frequency inverter driven motor for a soft start and stop.

The robust steel, IP54 classified, control box is easy to operate and to program. The mechanical main switch and emergency stop make it foolproof. The clear display gives a wide range of information like an easy to read cycle counter.

Break-away - and Automatic Repair system

Albany high speed doors are equipped with a break-away - and automatic repair system. The curtain reintroduces itself after a crash to reduce downtime and maintenance.

Completely safe

Features that make our doors completely safe.

- The soft bottom edge has no rigid parts, it moulds around any obstruction to prevent injury or damage.
- When an object hits the door, the fabric curtain absorbs the impact and releases itself from its side guides without causing damage or being damaged itself.

Windows and vision panels

To increase the admission of daylight and visibility, the door curtain can be equipped with windows or vision panels. Windows have fixed sizes in a grid. A vision panel uses the full width of the door curtain.

Insulated curtain

An insulated curtain with an increased static insulation of 2,41 W/(m²K) is available as an option.

Technical Data

Min size (W x H)	1000 x 2000 mm
Max size (W x H) ¹⁾	5500 x 5500 mm
Operating speed	opening: up to 2,4 m/s ² closing: 1,2 m/s
Wind load resistance, EN 12424	class 1 (300 N/m ²)
Water penetration, EN 12425	class 2 (50 N/m ²)
Air permeability, EN 12426	class 1 (24 m ³ /m ² /h at 50 Pa)
Thermal transmittance	6,02 W/(m ² K)
Lifetime expectations	1.000.000 cycles

1) Other sizes available on request 2) Depending on door size

Dimensional specifications

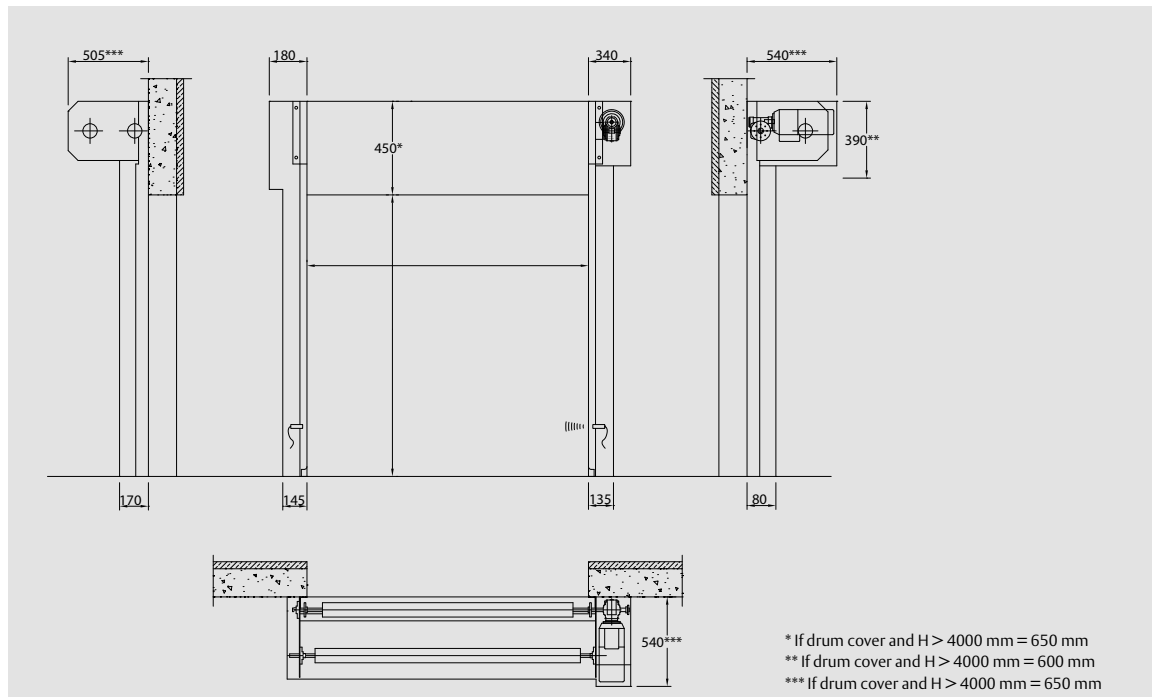



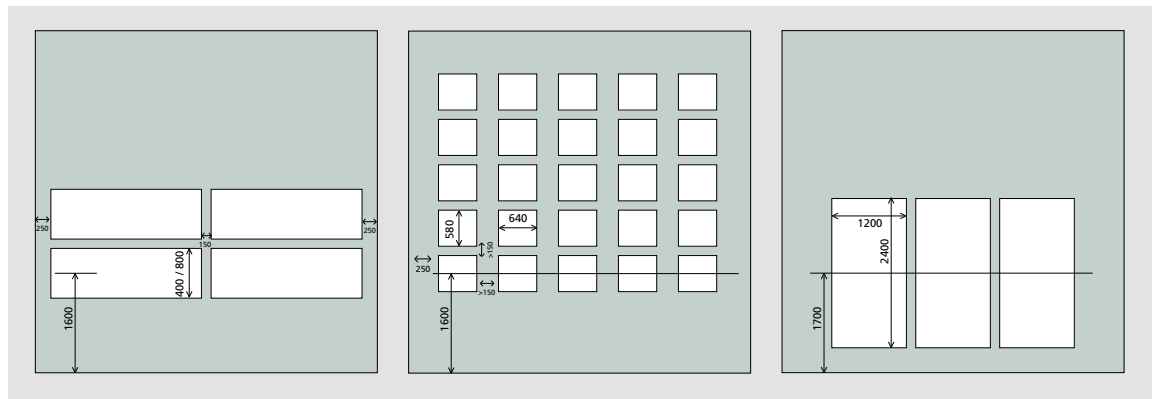



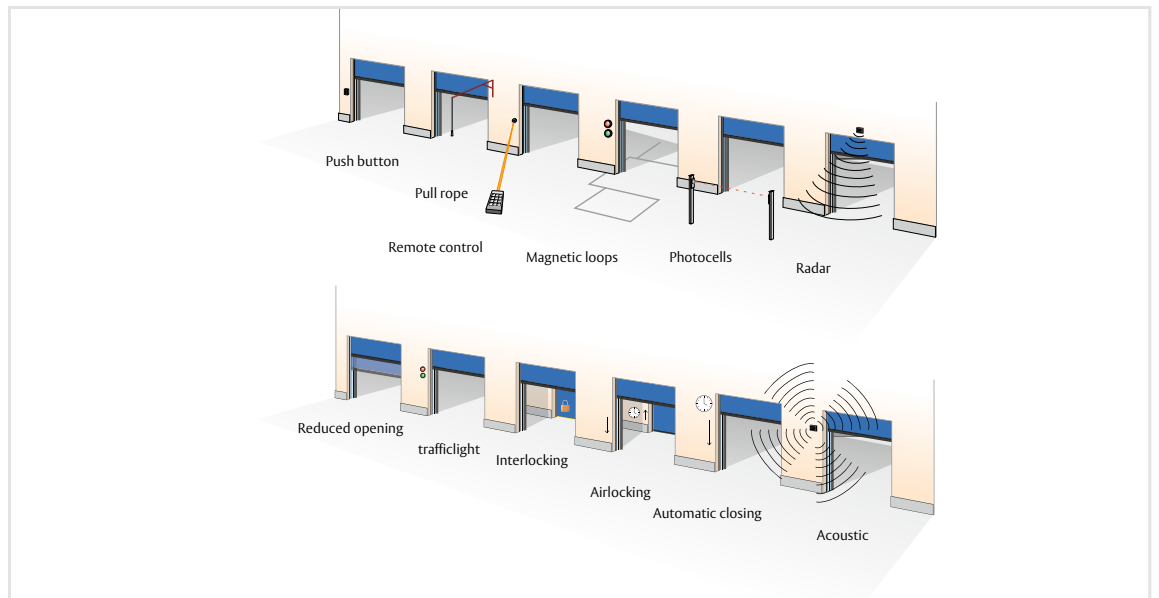

Windows and Vision panels



Options access and automation



Standard available colours

 Signal yellow RAL 1003	 Flame red RAL 3000	 Moss green RAL 6005	 Jet black RAL 9005	 On request Other colours
 Pure orange RAL 2004	 Ultramarine blue RAL 5002	 Light grey RAL 7035	 White RAL 9010	